

Crestron SmarTouch™ STX-1700C

5.7" 2-Way Wireless Touchpanel



The STX-1700C is a stylish and compact 2-way wireless touchpanel featuring a brilliant 5.7" active matrix touchscreen and optional pushbuttons. Isys color graphics and reliable RF communications combine to deliver amazing touchpanel performance with complete freedom of movement.

SmarTouch—A SmarTouch touchpanel offers an ideal user-interface for controlling home theater, boardroom AV and a host of other applications, providing a wide-open canvas for the creation of custom control screens tailored to the user's unique needs and tastes. Incredibly compact and portable, the SmarTouch touchpanel does away with piles of remotes and cryptic control panels, affording true "one-touch" control over a broad range of complex devices and systems.

2-Way RF Wireless with Roaming—With an indoor range of 50 feet using a single STRFGWX RF gateway (sold separately), the STX-1700C is excellent for small, single room applications, and for roaming applications utilizing multiple gateways. Bidirectional communication supports true-feedback and dynamic text capability to enable display of all kinds of data – from system power status and audio settings to digital media playlists, satellite radio program guides, alert messages, room temperature, lighting levels, and much more.

Isys—The powerful Isys engine produces astonishing 16-bit full-color graphics with lightning-fast performance and incredible versatility. The 32-bit Motorola ColdFire® microprocessor combines with an ingenious and ultra efficient operating system to support high-resolution graphics and images, dynamic text, animations, multimode objects (buttons, frames, gauges, and sliders), subpages, and more.

Synapse™—Crestron's exclusive Synapse Image Rendering Algorithm enables system programmers to produce amazing graphics – faster and easier. Advanced antialiasing delivers crisper, sharper objects and text. Enhanced 3D effects add new depth and style. And because Synapse is native to the touchpanel, memory requirements and upload time are substantially reduced.

Quick-Touch Pushbuttons—The STX-1700C includes a button bezel kit which may be installed to provide ten tactile pushbuttons for quick-touch access to frequently used commands. In standby, the pushbuttons may be operated without waking the touchscreen for extended battery life. Custom engraving of the pushbuttons may be attained using Crestron Engraver software.

Long-Life NiMH Batteries—A fast-charging NiMH battery pack is included to provide long-lasting wireless operation, with adjustable power management built in to preserve battery life up to 20 hours in standby.

Docking Station/Charger—Without removing the battery pack, the touchpanel can be placed in the ST-DSN docking station (included) for easy recharging, simultaneously providing operating power to the touchpanel. The docking station may also be used to recharge a spare ST-BTPN battery pack (sold separately). And if necessary, the touchpanel may even be powered directly using the PW-1215 power pack (included).

> 2-way RF Wireless with Roaming Capability

> 5.7" Active Matrix Touchscreen Display | 320 x 240 Resolution

> Isys Graphics Engine | Synapse Image Rendering Algorithm

> 10 Quick-Touch Pushbuttons (optional) | Audible "Key Click"

> Long-lasting NiMH Batteries | Docking Station/Charger Included

> Lightweight Contoured Design for Tabletop and Handheld Use

SPECIFICATIONS

Touchscreen Display

Display Type: Active matrix color LCD
Size: 5.7 inch (14.5 cm) diagonal
Resolution: 320 x 240 pixels
Illumination: Backlit fluorescent
Viewing Angle: ±65° horizontal, +65°/-40° vertical
Touchscreen: Resistive membrane

Wireless

RF Transceiver: 418 MHz 2-way RF
Range: 3 to 50 feet min/max indoor, 150 feet outdoor
STRFGWX gateway/transceiver required (maximum 15 touchpanels per gateway)

Processor

CPU: 32-bit Motorola ColdFire® Microprocessor
Processing Speed: 63 MIPS (Dhrystone 2.1 benchmark)

Memory

4MB flash, 8MB DRAM

Graphic Engine

Isys engine, 16 Bit non-palette graphics, 65,536 colors, Synapse image rendering algorithm

Buttons

(10) Replaceable engravable buttons, programmable
Requires installation of button bezel kit, included

Connectors

Power: (1) 12 Volt DC power jack (PW-1215 power supply included)

Cresnet Upload: (1) 3.5 mm mini TRS phone jack
Connects to Cresnet control network while uploading only

Power Requirements

Battery: ST-BTPN NiMH battery pack, 4.8 Volt, 4100 mAh (included)
Usage per Charge: 3 hours continuous use at full brightness, 20 hours in standby
Charging Time: 2.7 to 6 hours (depending upon use while charging)
Docking Station/Charger: ST-DSN (included)
Power Supply: 18 Watts (1.5 Amps @ 12 Volts DC) PW-1215 power supply included

Environmental

Temperature: 50° to 113°F (10° to 45°C)
Humidity: 10% to 90% RH (non-condensing)

Enclosure

Construction: High impact black/silver injection-molded case

Crestron SmarTouch™ STX-1700C 5.7" 2-Way Wireless Touchpanel

Dimensions

Height: 3.85 in (9.78 cm)
Width: 8.75 in (22.23 cm)
Depth: 5.51 in (14.00 cm)

Weight

1.85 lbs (0.84 kg) – not including battery or docking station

SPECIFICATIONS for ST-DSN Docking Station (included with STX-1700C):

Connectors

Power: (1) 12 Volt DC power jack (PW-1215 power supply included)

LED Indicators

Power (Logo): (green) Indicates 12 Volts DC from power supply
CHG: (red) Indicates battery charging status
RDY: (green) Indicates battery is fully charged

Power Requirements

1500 mA @ 12 Volts DC (PW-1215 power supply included)

Environmental

Temperature: 32° to 104°F (0° to 40°C)
Humidity: 10% to 90% RH (non-condensing)

Enclosure

High impact black injection-molded case

Dimensions

Height: 0.94 in (2.38 cm)
Width: 6.72 in (17.06 cm)
Depth: 6.77 in (17.18 cm)

Weight

15.8 ozs (0.49 kg) – not including power supply

INTERNATIONAL VERSION (230 VAC)

STXI-1700C

All the features and specifications of the STX-1700C except:

Power Requirements

PWI-1215 power supply included



STX-1700C
 Shown with
 Quick-Touch Buttons
 (engraving not included)

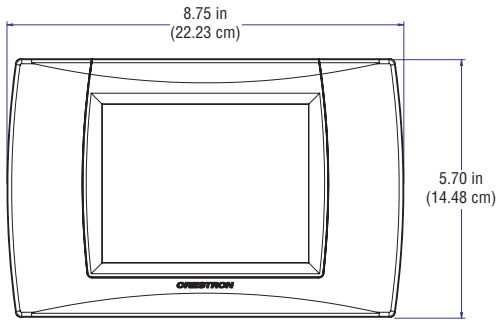

STX-1700C Touchpanel – Top View (face up)

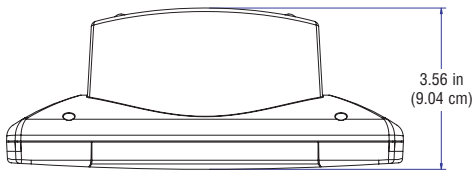

STX-1700C Touchpanel – Rear View (face down)

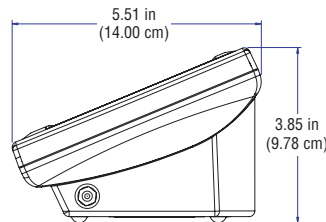

STX-1700C Touchpanel
 Right Side View

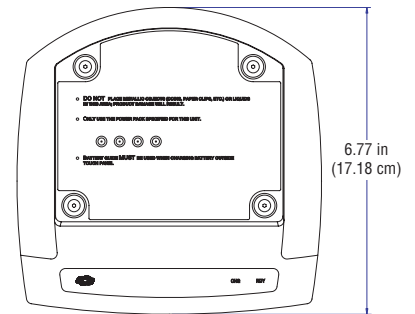

ST-DSN Docking Station – Top View

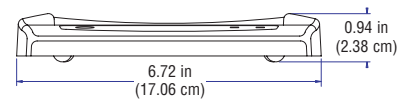

ST-DSN Docking Station – Front View

AVAILABLE ACCESSORIES



STRFGWX(I)
 2-Way 418 MHz RF Gateway



ST-BTPN
 Battery Pack
 (1 included)



ST(I)-DSN
 Docking Station
 (1 included)



PW(I)-1215
 Power Supply
 (1 included)

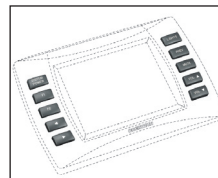

1700C-BTNB
 Set of 10 Black Button Caps
 with Engraving

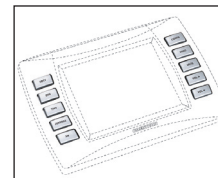

1700C-BTNS
 Set of 10 Silver Button Caps
 with Engraving



ST-PK
 Programming Cable
 Kit